

# Dummy 65mm Lever Sets

SUITS DOORS 26mm TO 45mm THICK

## Step 1. Door Preparation

- Fold the supplied template and position template on door edge.
- Mark centre of all three holes as indicated on template.
- Pilot drill all three holes.
- Drill 25mm hole either all the way through door, or 10mm deep on the side of door where lever will be mounted.
- Drill two 10mm holes through door.

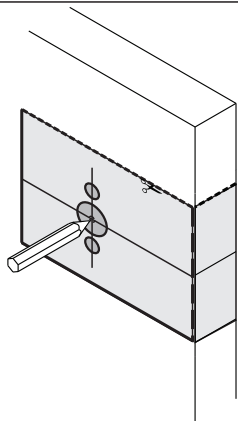

## Step 2. - Remove Rosette-Cap

- Remove rosette cap from lever assembly.
- Square caps may need hex screws loosened on corner of cap to allow removal.

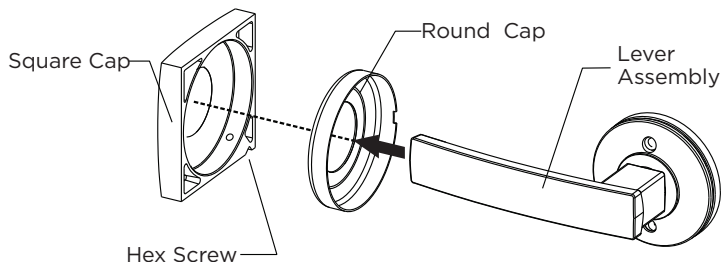

## Step 3. - Lever Installation

- Place lever assembly onto outside of door.
- Place mounting plate onto inside of door.
- Insert mounting screws (M4 x 38mm) through holes in lever assembly. Tighten both screws.

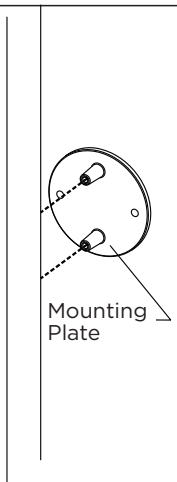
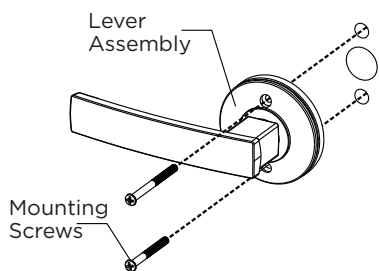

## Step 4. - Door Screw Installation

- Check whether lever assembly is sitting horizontally. If required loosen mounting screws, straighten lever assembly and re-tighten screws.
- Once lever is horizontal, screw in two door screws (#6 x 19mm) through mounting plate.

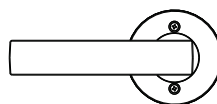

**CHECK LEVER ASSEMBLY IS HORIZONTAL BEFORE SCREWING IN DOOR SCREWS.**

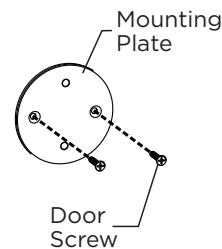

## Step 5. - Rosette-Cap Installation

- For round caps, push round-cap onto the lever assembly, until the cap is flush with the door face.
- For square caps, place square cap over the lever assembly. Orientate the hex screw hole towards the bottom of the door, position cap squarely then tighten hex screw to hold cap in place.

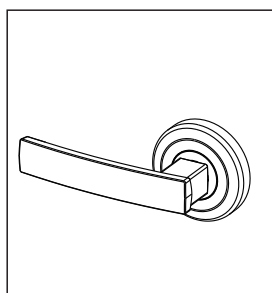
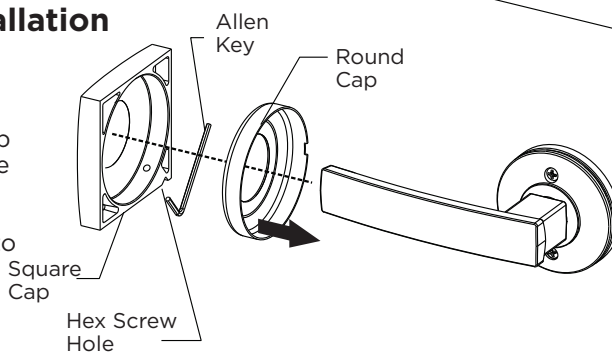

**DEL F ARCHITECTURAL**  
 T 1300 362 625 F 1300 362 643  
 E sales@delfarchitectural.com.au  
 W www.delfarchitectural.com.au

## DOOR TEMPLATE

Fold on dotted line and fit on door edge

